

SECTION A-A

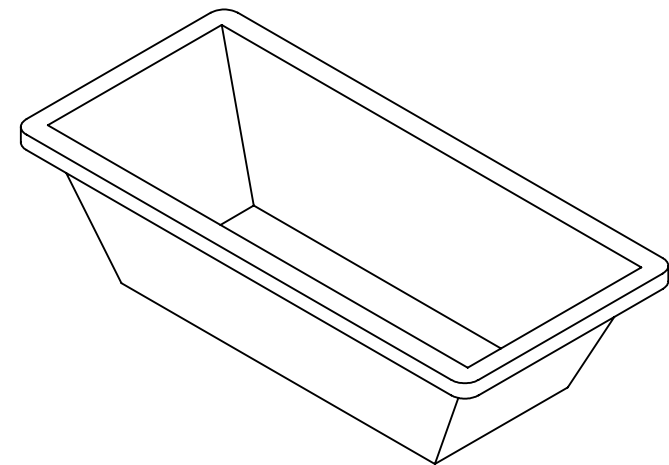
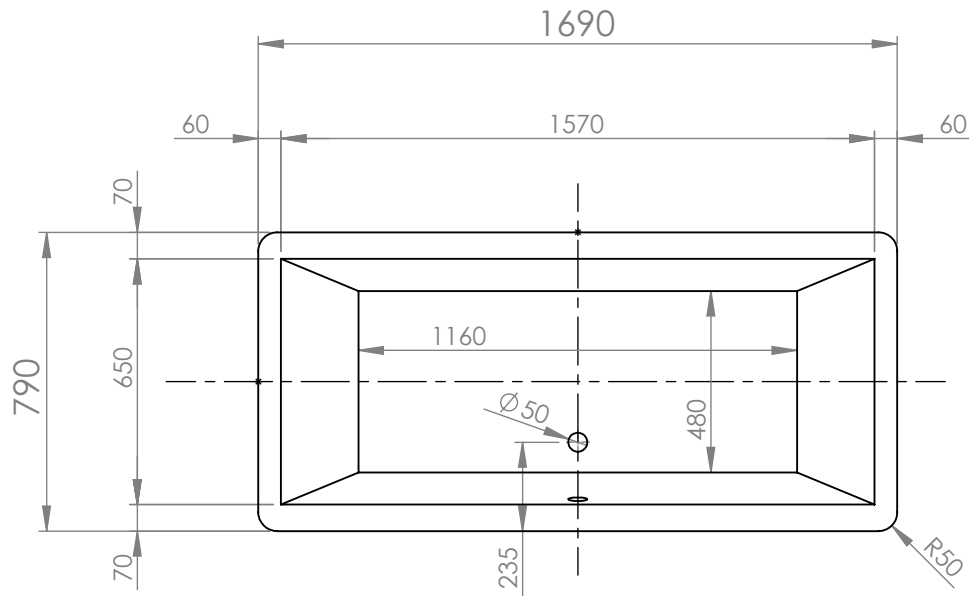

		TITLE:	
		BATHTUB STYLE 170X80	
DRAWN	DATE	NAME	DWG NO.
	04/07/2021	KONSTANTINOS PAIZANOS	A4
		SCALE:1:20	SHEET 1 OF 1