

STARLET

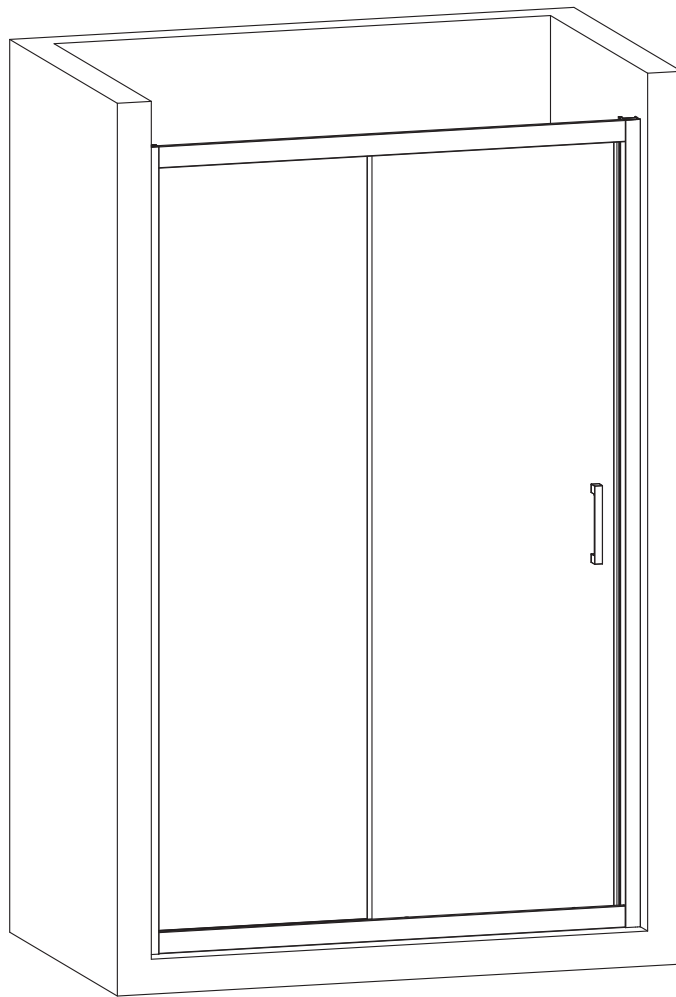









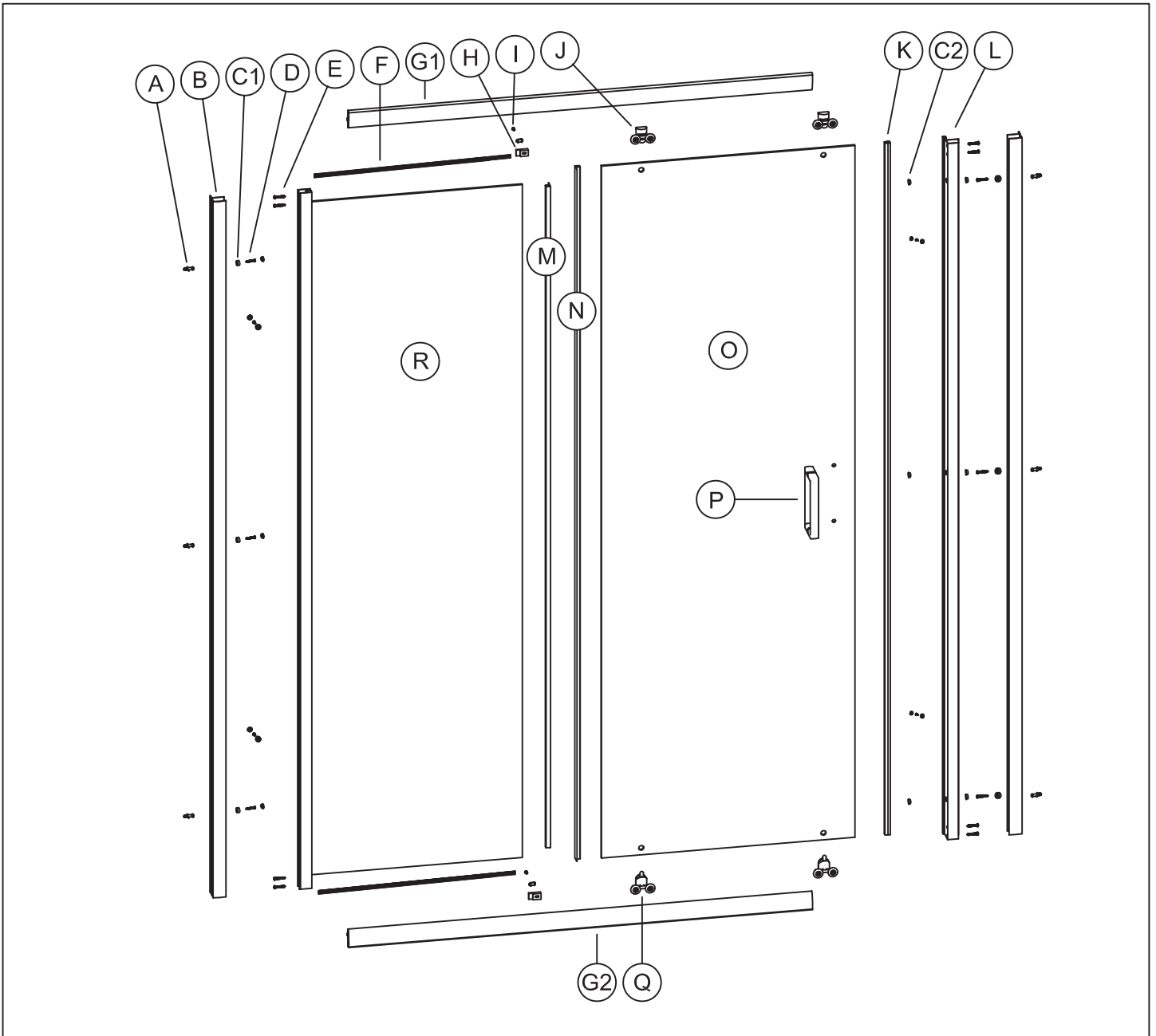



WARRANTY

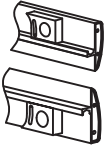

Αυτό το προϊόν είναι βαρύ και απαιτεί 2 ανθρώπους για την εγκατάστασή του.

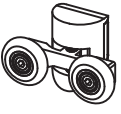

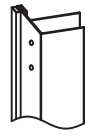
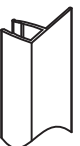
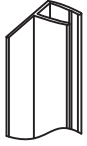
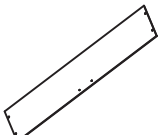

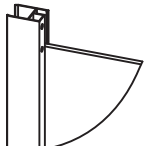
<p>A</p>  <p>Ø6*30 X6</p>	<p>B</p>  <p>X2</p>	<p>C</p> <p>C1 C2</p>  <p>X10 X13</p>	<p>D</p>  <p>ST4.2*32 X6</p>	<p>E</p>  <p>ST3.5*32 X8</p>	<p>F</p>  <p>X2</p>
<p>G</p> <p>G1 G2</p>  <p>X2</p>	<p>H</p>  <p>X2</p>	<p>I</p>  <p>ST3.5*9.5 X6</p>	<p>J</p>  <p>X2</p>	<p>K</p>  <p>X1</p>	<p>L</p>  <p>X1</p>
<p>M</p>  <p>X1</p>	<p>N</p>  <p>X1</p>	<p>O</p>  <p>X1</p>	<p>P</p>  <p>ST3.9*32 X1</p>	<p>Q</p>  <p>X2</p>	<p>R</p>  <p>X1</p>

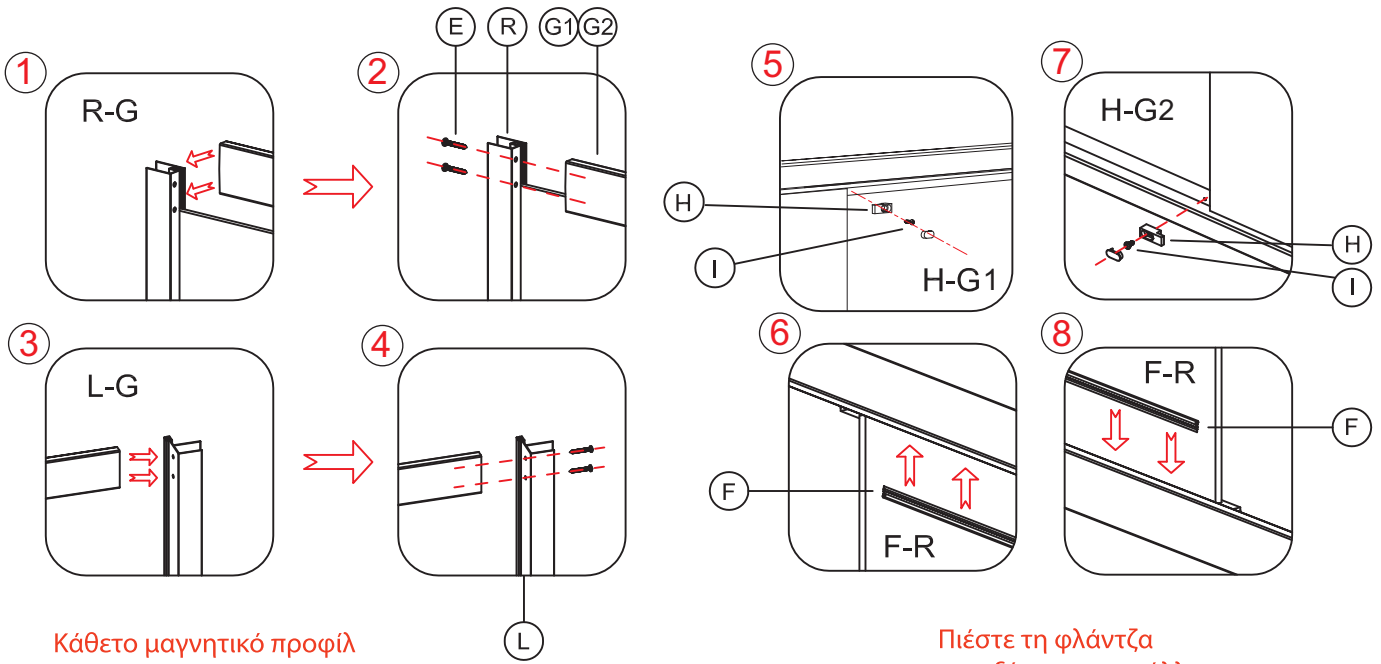

Κάθετο μαγνητικό προφίλ

Πιέστε τη φλάντζα
μεταξύ του κρυστάλλου
και του οριζόντιου προφίλ

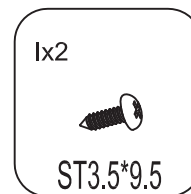
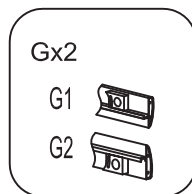
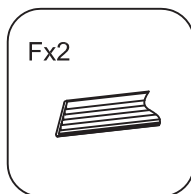
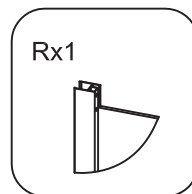
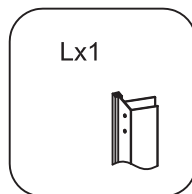
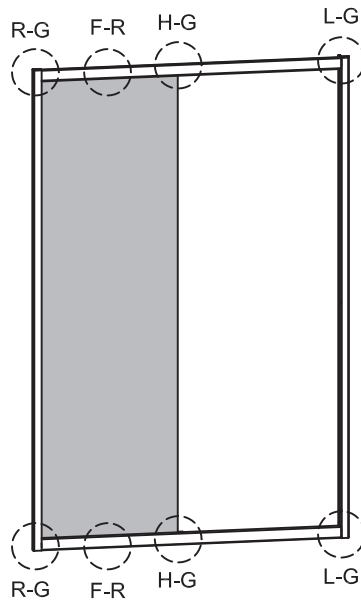

Bx2

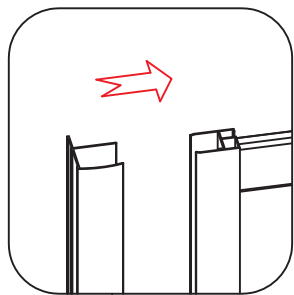

B

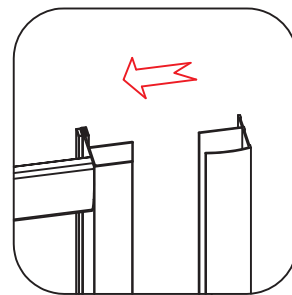
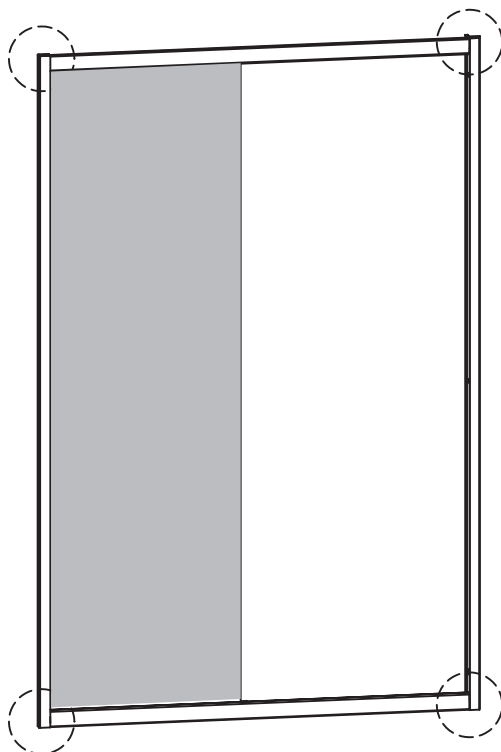

B

Ax6



Ø6*30



Ø6

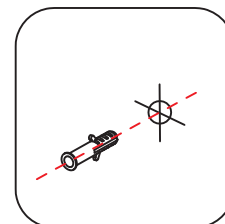
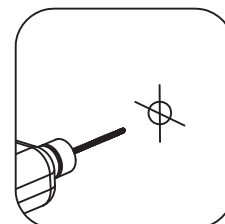
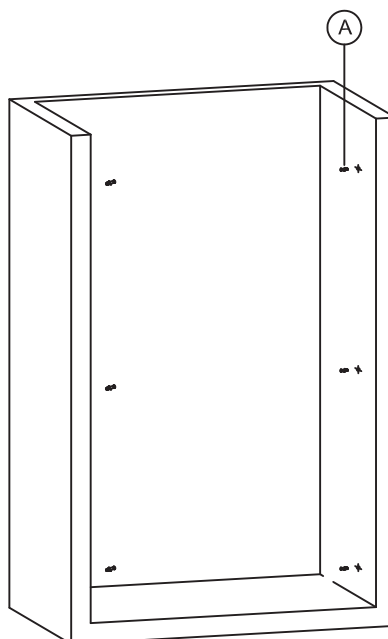
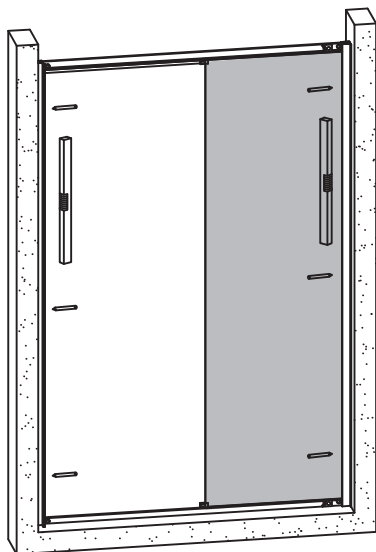

C1x6



C2x9



Dx6



ST4.2*32

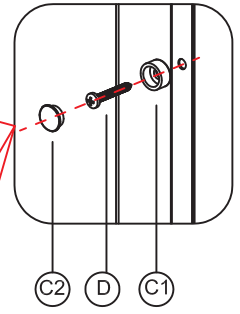
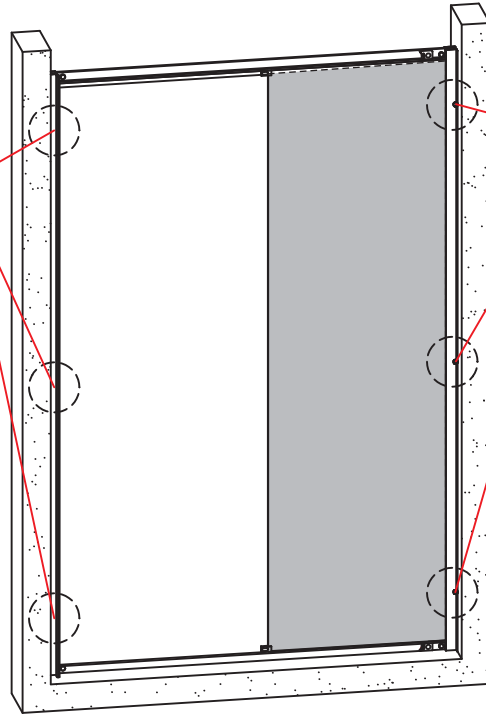
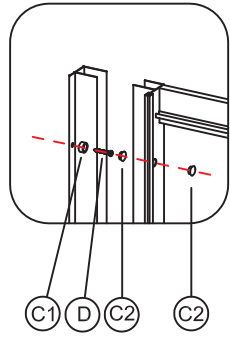

C1x4



C2x4



Ix4



ST3.5*9.5



Ø2.8

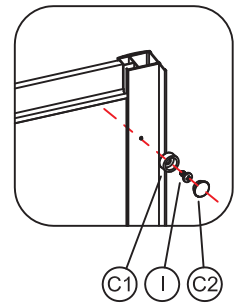
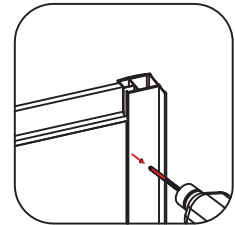
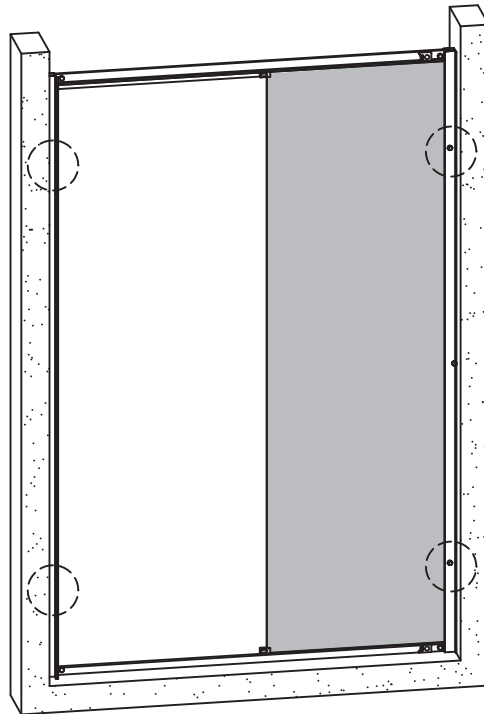

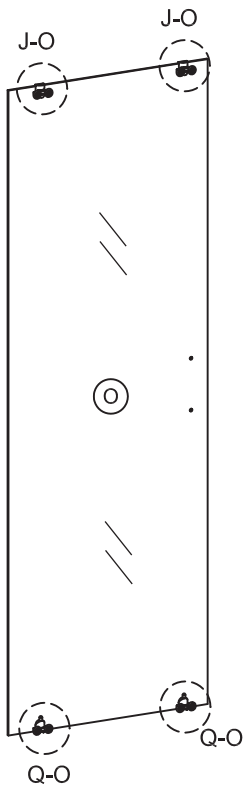
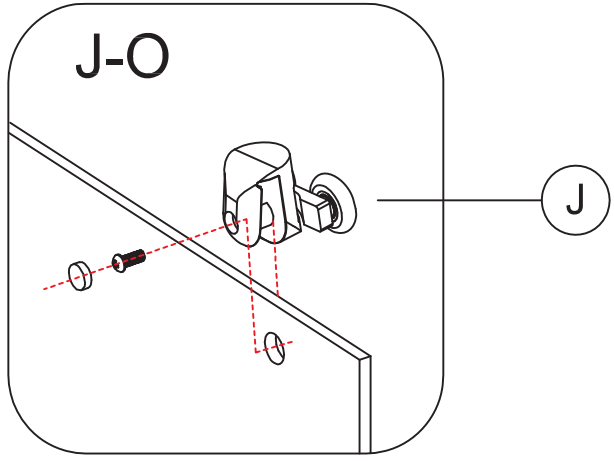
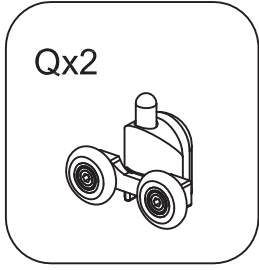
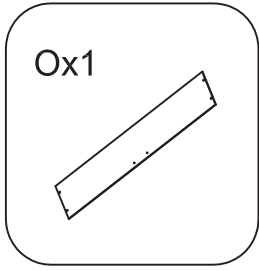
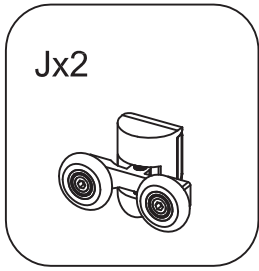

Ροδάκια άνω

Ροδάκια κάτω

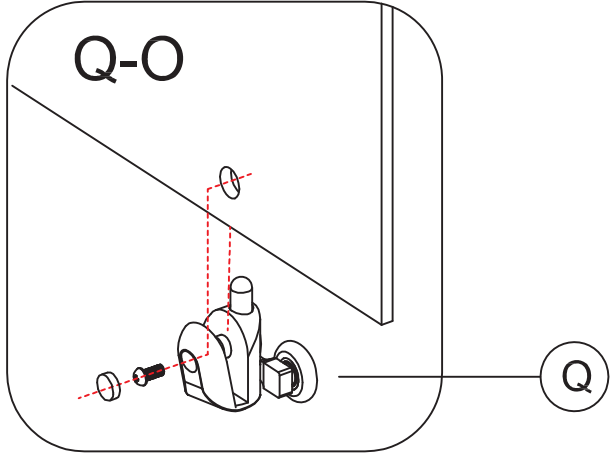

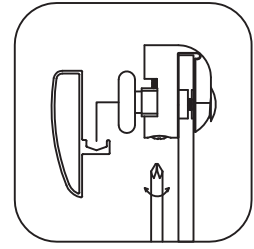
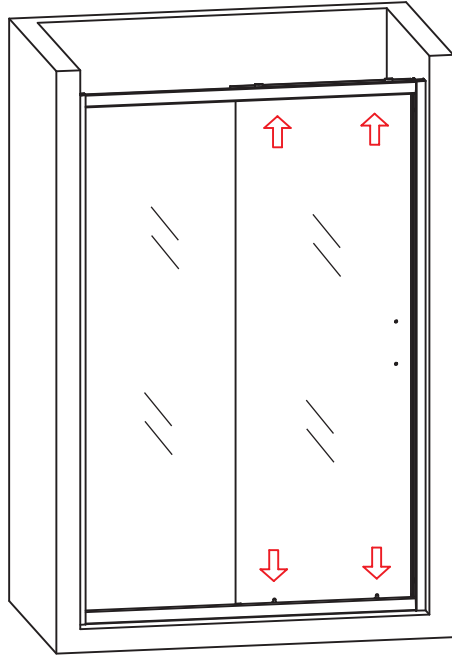

Ρύθμιση ύψους πόρτας

